



Requirements for applying for a sign permit under By-Law No. 1353-00



To help prevent any unnecessary delays in the processing of your sign permit, please read the following information.

1. Complete all portions of the sign permit application, date and sign. Incomplete applications will **not** be processed.
2. Every application must be provided with the following information where applicable:
 - a site plan showing the street and property boundaries of the property on which the sign is proposed to be erected;
 - the proposed location of the sign in relation to the other structures, property boundaries and adjoining premises;
 - plans or drawings to scale indicating the dimensions, the materials to be used in construction and the method of illumination;
 - side view (elevations) drawings to scale showing the size and height of the sign as well as the wording of the sign;
 - the method in which the sign will be erected;
 - when the sign is required to be designed by a professional, the drawings must bear his/her stamp and signature;
 - the full permit fee must be paid at the time the permit application is submitted to the Municipality of Wawa for processing.

FURTHER INFORMATION TO ASSIST YOU:

1. The permit fee will be calculated as follows:

First square metre (10 sq. ft.)	\$50.00
Each additional square metre (10 sq. ft.)	\$10.00
Alterations	\$50.00
2. No one shall erect, display, alter or repair any sign located within the Municipality of Wawa unless they have obtained a sign permit from the Chief Building Official. Where a sign has been erected before a permit is issued, the permit fee **will be doubled**.
3. Signs are **NOT** permitted within residential areas.
4. Signs cannot be erected so that they will interfere with the use of fire escapes, exit from buildings, windows, doors, stairways, sidewalks, or streets.
5. All projecting signs shall be erected, placed and maintained in such a manner that the following table shall be adhered to:

Minimum Height	Maximum Projection
11 feet (3.35 metres)	6 feet (1.83 metres)
12 feet (3.66 metres)	8 feet (2.44 metres)
13 feet (3.96 metres)	10 feet (3.05 metres)

6. Signs erected on posts (free standing) must have a minimum clear height of 1.5 metres (5 feet) measured from the ground to the bottom of the sign and where there is a base, i.e.: planters, it's maximum height cannot exceed 1 metre (3 feet).
7. Except for automotive service identification signs, signs cannot be located within the minimum side yards as indicated below:

ZONE	MINIMUM SIDE YARD
C1 – General Commercial	4.5 m * (14ft.-9in.)
C2 – Local Highway Commercial	3.0 m ** (9ft.-10in.)
C3 – Highway Commercial	—
C4 – Water Front Commercial	4.5 m * (14ft.-9in.)
MI – General Industrial	3.0 m *** (9ft.-10in.)
M2 – Restricted Industrial	4.5 m **** (14ft.-9in.)
M3 – General Industrial	15 m (49ft.)
I – Institutional	3.0 m ** (9ft.-10in.)
RU – Rural	1.2 m (4ft.)

- * If abutting a Residential Zone only.
- ** If abutting a street, the minimum side yard shall be 3.5 metres (11ft.-5in.)
- *** If abutting a Residential Zone, the minimum side yard shall be 7.5 metres (24ft.-7in.)
- **** If abutting a Residential Zone, the minimum side yard shall be 15 metres (49ft.)

Note: This information is of a general nature only. Please refer to the By-Law for the legal interpretation.

SITE PLAN

EXAMPLE 1

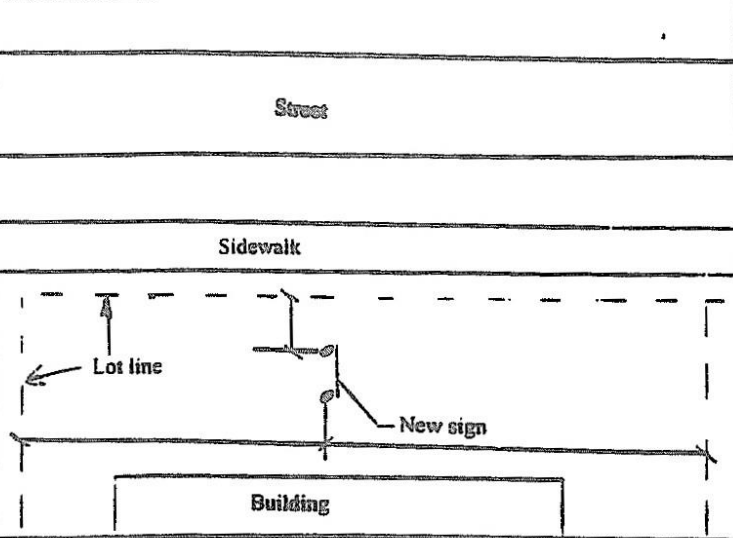

EXAMPLE 2

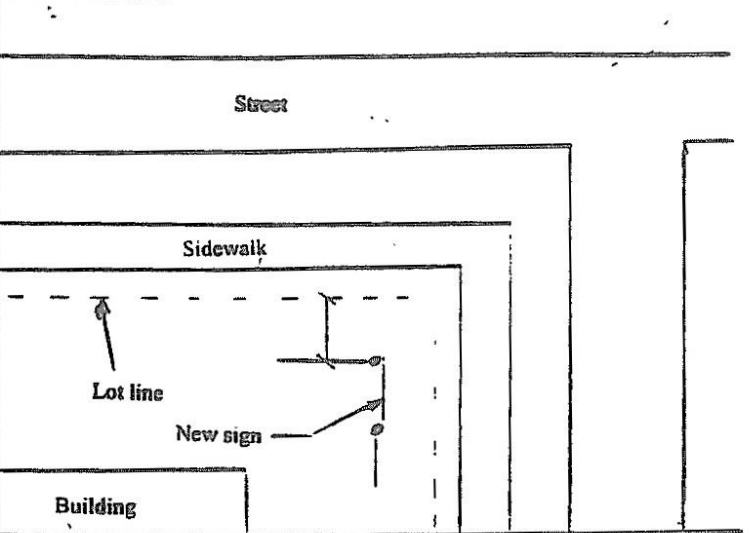

EXAMPLE 3

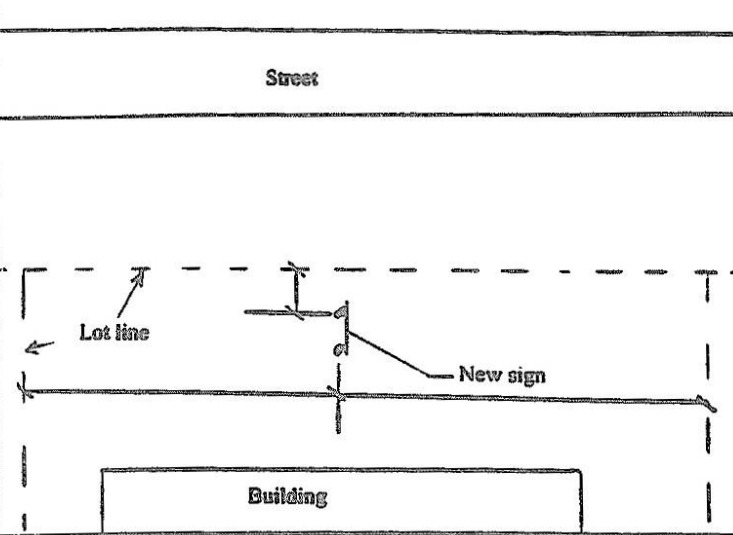

EXAMPLE 4

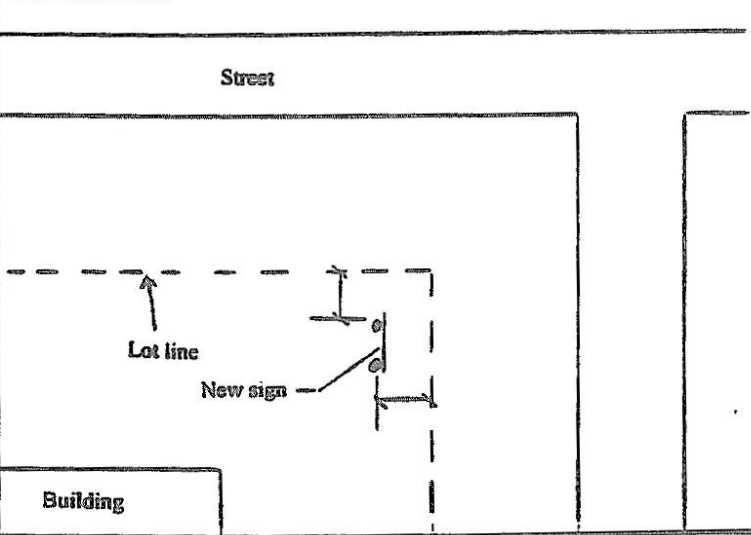

ELEVATIONS

EXAMPLE 1

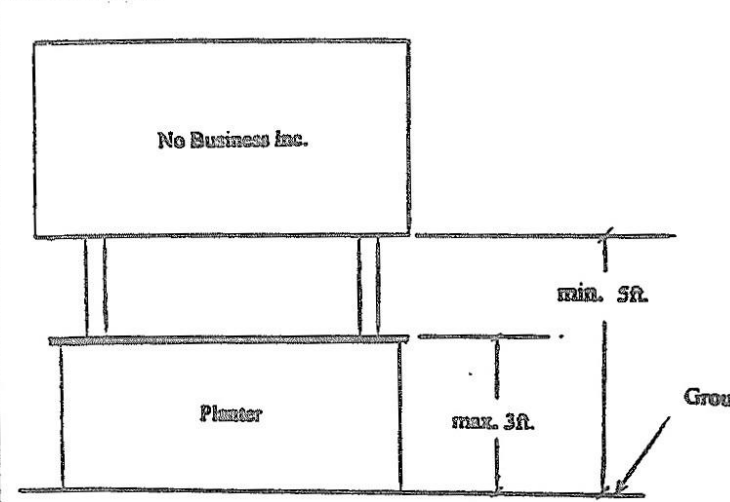

EXAMPLE 2

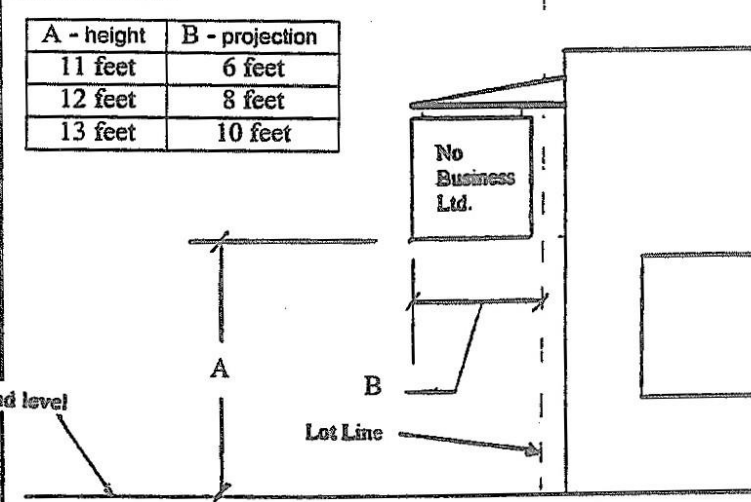

EXAMPLE 3

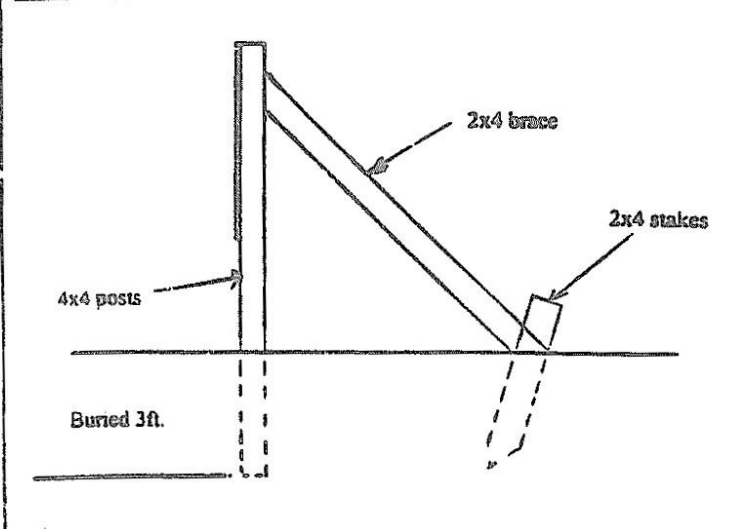

EXAMPLE 4

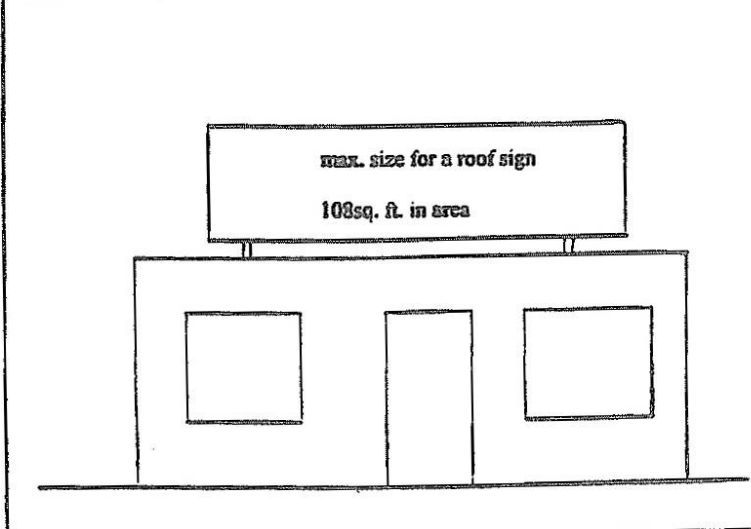



Municipality of Wawa
Building Department
Sign Permit Application
 (By-Law No. 1353-00)



For Office Use:
PERMIT NO.: _____
PERMIT FEE: _____
DATE ISSUED: _____

APPLICANT:

Name of Applicant:	_____
Mailing Address:	_____
Phone Number:	_____

BUSINESS WHICH SIGN WILL REPRESENT:

Business Name:	_____
Business Address:	_____
Phone Number:	_____
Sign Location: (address or property description)	_____

PERSON(S) ERECTING THE SIGN — SAME AS APPLICANT.

Name:	_____
Address:	_____
Phone Number:	_____
Sign Location: (address or property description)	_____

TYPE OF PERMIT BEING APPLIED FOR:

<input type="checkbox"/> NEW SIGN	<input type="checkbox"/> ALTERATION	<input type="checkbox"/> OTHER
-----------------------------------	-------------------------------------	--------------------------------

TYPE OF PERMIT BEING ERECTED:

<input type="checkbox"/> free standing	<input type="checkbox"/> wall sign	<input type="checkbox"/> roof	<input type="checkbox"/> other
--	------------------------------------	-------------------------------	--------------------------------

INDICATE THE DOCUMENTS BEING SUBMITTED WITH THE APPLICATION

<input type="checkbox"/>	A site plan showing the street and property boundaries of the property on which the sign is proposed to be erected, the proposed location of the sign in relation to the other structures, property boundaries and adjoining premises;
<input type="checkbox"/>	Plans or drawings to scale indicating the dimensions, the materials to be used in the construction and the erection and the method of illumination;
<input type="checkbox"/>	Side view (elevations) drawings to scale showing the size and height of the sign as well as the wording of the sign;
<input type="checkbox"/>	When the sign is required to be designed by a professional, the drawings must bear his stamp and signature (see reverse side for professional designed requirements);
<input type="checkbox"/>	Other document:

DECLARATION:

I am the owner or authorized agent of the owner of the above application, and I certify the truth of all the statements and representation contained herein and attached hereto.
I agree if a permit is issued, not to depart from the plans, specifications or location proposed in this application.

_____ Date of Application

_____ Applicant's Signature

Requirements for a professional design:

1. A sign structure shall be designed by an Architect or Professional Engineer where it is:
 - a ground sign which exceeds 7.5 m (24ft.-7in.) in height above the adjacent finished ground; or
 - a projecting sign which weighs more than 115 kg (245lbs.); or
 - a sign mounted on a roof with any one face having a surface area exceeding 10 sq. m. (108sq.ft.)
2. A projecting sign shall not be attached or fastened in any manner to a parapet wall unless designed by an ARCHITECT OR PROFESSIONAL ENGINEER.

For office use:

Permit Application Review

Date: _____

3.2 Signs designed by a professional must bear his/her stamp and signature

2.2 Signs shall not be located within a residential zone

4.4 Projecting sign shall be erected, placed and maintained in such a manner that to the following table shall be adhered to:

Minimum Height	Maximum Projection
11 feet (3.35 metres)	6 feet (1.83 metres)
12 feet (3.66 metres)	8 feet (2.44 metres)
13 feet (3.96 metres)	10 feet (3.05 metres)

4.5 Projecting sign cannot extend over 10 ft. Over lot line i.e. municipal property

4.6 Free standing sign must have a clear height of 5 ft. To the bottom and the base no higher than 3 ft.

4.8 Signs located in side yards must comply with schedule "C"

Signs cannot interfere with another business, driveway, sidewalk or street

In compliance Not in compliance Subsequently corrected Not applicable

REMARKS: SEE ATTACHED.

APPROVED BY: _____

On site inspection

Date: _____

3.2 Signs designed by a professional must bear his/her stamp and signature

2.2 Signs shall not be located within a residential zone

4.4 Projecting sign shall be erected, placed and maintained in such a manner that to the following table shall be adhered to:

Minimum Height	Maximum Projection
11 feet (3.35 metres)	6 feet (1.83 metres)
12 feet (3.66 metres)	8 feet (2.44 metres)
13 feet (3.96 metres)	10 feet (3.05 metres)

4.5 Projecting sign cannot extend over 10 ft. Over lot line i.e. municipal property

4.6 Free standing sign must have a clear height of 5 ft. To the bottom and the base no higher than 3 ft.

4.8 Signs located in side yards must comply with schedule "C"

Signs cannot interfere with another business, driveway, sidewalk or street

In compliance Not in compliance Subsequently corrected Not applicable

REMARKS: SEE ATTACHED.

APPROVED BY: _____